

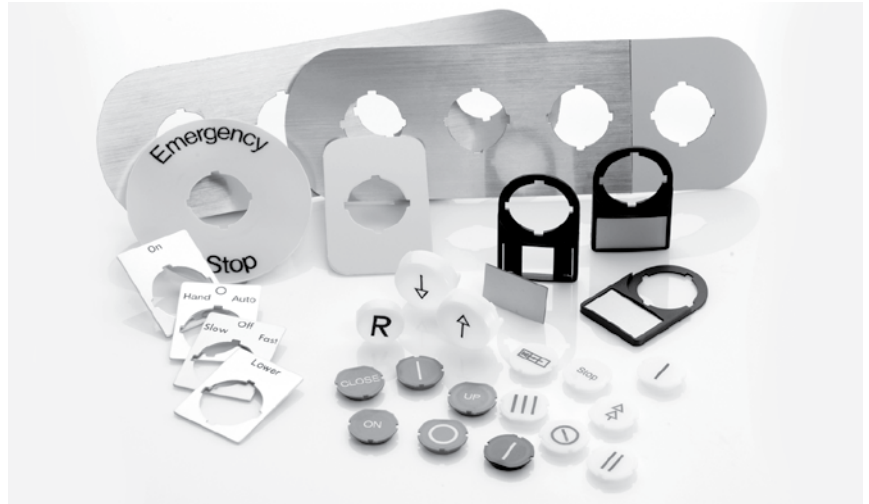

Legend plates

22mm



8

22mm Legend plates

Fixed legend plates

- Of silvergrey anodized aluminum for:
 - pushbuttons
 - two-position selector switches
 - three-position selector switches
 - toggle switches
 - customer selected text

Special legend plates

- For emergency stop pushbuttons
- Legend plate with or without customer selected text
- Legend plate holders with inserts of anodized brushed aluminum
With or without text or symbol for:
 - pushbuttons
 - two-position selector switch
 - three position selector switch
 - customer selected textFor plastic enclosures:
- Legend plate holders with inserts of anodized brushed aluminum on black plastic.
With or without text or symbol for push-buttons
- Legend plates of silvergrey anodized aluminum. For 1- 2-, 3- 4- or 6-seat plastic enclosures

Text caps

- For illuminated pushbuttons (flush or extended) and pilot lights with or without text or symbol or with customer selected text.

Special legend plates 22mm

Legend plate holders with inserts

- Holder of black plastic.
 - Holder of grey plastic for plastic enclosures.
 - Insert of brushed aluminum on black plastic.
- The insert is securely retained in a pocket and can be removed.
3 mm high text in typeface Helvetica.

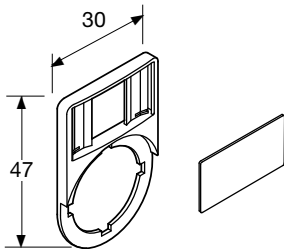
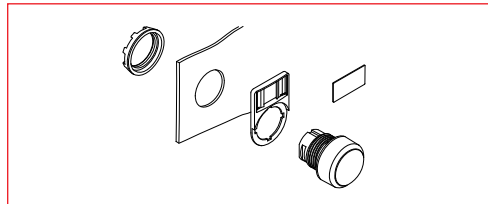

Legend plate holder (black) for panel mounting

Description	Catalog No.	List Price
Black	1SFA 616 920 R8120	\$ 0.70

Inserts

Description	Catalog No.	List Price
Of brushed aluminum on black plastic Without text or symbol	1SFA 616 920 R8121	\$ 0.70

Inserts with text/symbol

Description	Catalog No.	List Price
Of brushed aluminum on black plastic With text or symbol		
O	1SFA 611 930 R1032	\$ 0.75
I	1SFA 611 930 R1033	
→	1SFA 611 930 R1034	
→→	1SFA 611 930 R1035	
Close	1SFA 611 930 R1036	
Open	1SFA 611 930 R1037	
On	1SFA 611 930 R1038	
Off	1SFA 611 930 R1039	
Fast	1SFA 611 930 R1040	
Slow	1SFA 611 930 R1041	
Down	1SFA 611 930 R1042	
Up	1SFA 611 930 R1043	
Start	1SFA 611 930 R1044	
Stop	1SFA 611 930 R1045	

Inserts for two-position selector switches

Of brushed aluminum on black plastic. Text on both sides.

Description	Catalog No.	List Price
With text or symbol		
Pos. 21 Pos. 22		
O I	1SFA 611 930 R 1070	\$ 0.75
I II	1SFA 611 930 R 1071	
→ →→	1SFA 611 930 R 1072	
Off On	1SFA 611 930 R 1073	
Stop Start	1SFA 611 930 R 1074	
Low High	1SFA 611 930 R 1075	
Slow Fast	1SFA 611 930 R 1076	
Close Open	1SFA 611 930 R 1077	
Jog Run	1SFA 611 930 R 1078	
Hand Auto	1SFA 611 930 R 1079	

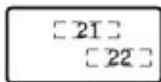

For two-position selector switch

Special legend plates 22mm

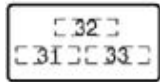

For three-position selector switch

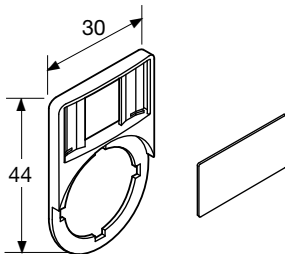

Inserts for three-position selector switches

Of brushed aluminum on black plastic. Text on both sides.

Description	Catalog No.	List Price
<u>With text or symbol</u>		
Pos. 31 Pos. 32 Pos. 33		
← O →	1SFA 611 930 R 1080	\$ 0.75
→ O →→	1SFA 611 930 R 1081	
I O II	1SFA 611 930 R 1082	
Hand O Auto	1SFA 611 930 R 1083	
Slow Off Fast	1SFA 611 930 R 1084	

Legend plate holder (grey) for plastic enclosures

Description	Catalog No.	List Price
Grey	1SFA 611 930 R1060	\$ 0.75

Inserts

Description	Catalog No.	List Price
Of brushed aluminum on black plastic		
Without text or symbol	1SFA 611 930 R1061	\$ 0.50

Inserts with text/symbol

Description	Catalog No.	List Price
Of brushed aluminum on black plastic		
<u>With text or symbol</u>		
O	1SFA 611 930 R1062	\$ 0.75
I	1SFA 611 930 R1063	
II	1SFA 611 930 R1064	

Special legend plates Emergency stops 22mm

Emergency stop legend plates, 70mm, for modular enclosures ①



SK 615 546-2



CA6-1026

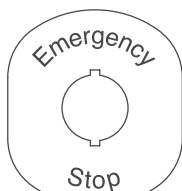

MA6-1101

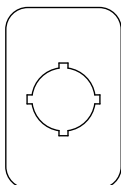

1SFA 611 930 R1011

Description/Text	Catalog No.	List Price
Black text on a yellow aluminum plate. Emergency Stop Without text	SK 615 546-2 SK 615 546-8	\$ 6.00
Black text on a yellow plastic plate. Can be used as yellow background. Emergency Stop	1SFA 616 915 R1005	5.00

Emergency stop legend plates, 60mm, for Compact enclosures

Description/Text	Catalog No.	Order code	List Price
Legend plate, yellow aluminum, 60mm	CA6-1026	1SFA619930R1026	\$ 6.00

Emergency stop legend plates for Modular enclosures

Description/Text	Catalog No.	Order code	List Price
For horizontally mounted enclosures with yellow plastic/black text	MA6-1026	1SFA611930R1026	\$ 25.00
For vertically mounted enclosures with yellow plastic/black text	MA6-1101	1SFA611930R1101	25.00

Emergency stop legend plate

Description/Text	Catalog No.	List Price
Black text on a yellow aluminum plate. Legend plate without text	1SFA 611 930 R1010	
Legend plate (1SFA 611 930 R1010) with text: Emergency Stop	1SFA 611 930 R1019	\$ 5.00
Black text on a yellow plastic plate. Legend plate without text	1SFA 611 930 R1011	4.00
Legend plate (1SFA 611 930 R1011) with text: Emergency Stop	1SFA 611 930 R1023	10.00

① Does not work with pushbutton enclosure.

② Quantity per package: 10.

③ When ordering, please state text and position (Line 21 and Line 22). Only the initial character is upper case unless other is stated. Quantity per package: 1.

Legend plates for pushbuttons 22mm

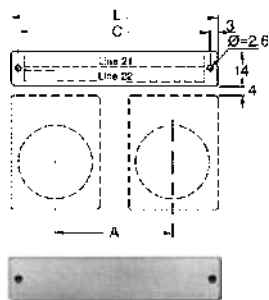
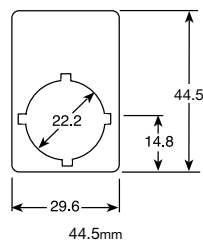
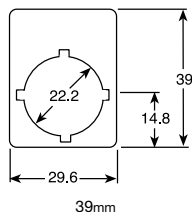

22mm Blank fixed legend plates

Of silvergrey aluminum

Size	Catalog No.	List Price
39mm H	SK 615 540-1	\$ 3.00
44.5mm H	SK 615 541-1	

22mm Engraved fixed legend plates, with text ①

Of silvergrey aluminum

Text	Catalog No.	List Price
English		
Close	SK 615 552-13	\$ 3.00
Down	SK 615 552-14	
Emergency stop	SK 615 552-15	
Fast	SK 615 552-16	
Forward	SK 615 552-17	
In	SK 615 550-29	
Inching	SK 615 552-18	
Jog	SK 615 552-JO	
Left	SK 615 552-39	
Lower	SK 615 552-20	
Off	SK 615 552-21	
On	SK 615 552-22	
Open	SK 615 552-23	
Out	SK 615 552-24	
Raise	SK 615 552-25	
Reset	SK 615 552-27	
Reverse	SK 615 552-28	
Right	SK 615 552-40	
Run	SK 615 552-29	
Slow	SK 615 552-30	
Start	SK 615 550-44	
Stop	SK 615 552-31	
Up	SK 615 552-32	

Legend plates without or with customer-selected text

Of aluminum

Number of operations	Max number of characters per line	Dimensions			Without text Catalog No.	List Price
		A	L	C		
1	7	-	29.6	23.6	SK 615 545-1	\$ 6.00
2	20	30.5	60	54	SK 615 545-2	
2	24	40	70	64	SK 615 545-3	
3	33	30.5	90	84	SK 615 545-4	
3	42	40	110	104	SK 615 545-5	

① Text height 3 mm.

Engraved legend plate form
Special legend plates
22mm

ENGRAVED LEGEND PLATE FORM

PAGE: ___ OF: ___

ORDER DATE: _____

ORDER NUMBER: _____

ISSUED BY: _____

ORDER QTY: _____

ALL CAPITALS? YES NO

SHIPPING METHOD: _____

REMARKS: _____

DUE DATE: ____ - ____ - ____

To be completed by ABB personnel:

ENGRAVER: _____

Q.C. INSPECTION: _____

PRINT INFORMATION TO BE ENGRAVED

MAX 7
CHARAC-
TERS PER
LINE

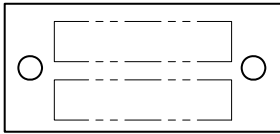

SK 615 545-1

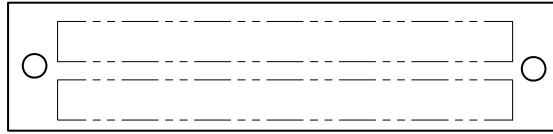

SK 615 545-2

MAXIMUM OF 20
CHARACTERS PER LINE

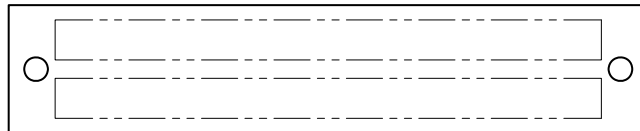

SK 615 545-3

MAXIMUM OF 24
CHARACTERS PER LINE

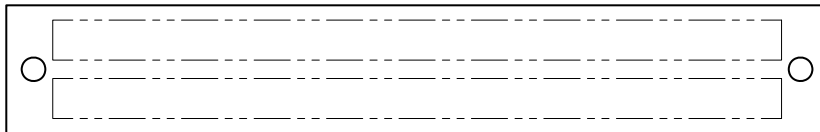

SK 615 545-4

MAXIMUM OF 33
CHARACTERS PER LINE

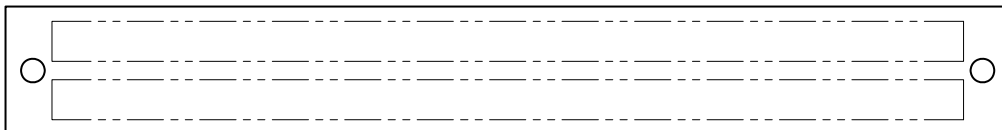

SK 615 545-5

MAXIMUM OF 44
CHARACTERS PER LINE

Legend plates for 2 position selector switches 22mm

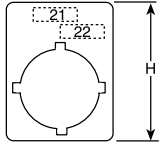

H = 39 mm

Engraved fixed legend plates, with symbols ①

Of silvergrey aluminum

Symbol/Text

Pos 21 Pos. 22

O I
I II
→ →→

Catalog No.

SK 615 550-75
SK 615 550-76
SK 615 562-72

List Price

\$ 3.00

Engraved fixed legend plates, with text ①

Of silvergrey aluminum

Symbol/Text

Pos 21 Pos. 22

English

Hand Auto
Jog Run
Off On
Stop Start

Catalog No.

SK 615 550-71
SK 615 552-52
SK 615 552-53
SK 615 552-55

List Price

\$ 3.00

① Text height 3 mm. Only the initial character is upper case unless other is stated.

Legend plates for 3 position selector switches 22mm

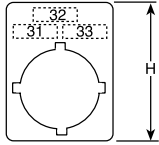

H = 39 mm

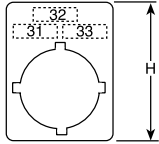

H = 39 mm

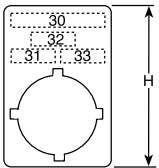

H = 44.5 mm

Engraved fixed legend plates, with symbols ①

Of silvergrey aluminum

Symbol/Text

Pos 31 Pos. 32 Pos. 33

I	○	II
←	○	→
→	○	→→

Catalog No.

List Price

SK 615 550-81

SK 615 562-82

SK 615 562-83

\$ 3.00

Engraved fixed legend plates, with text ①

Of silvergrey aluminum

Symbol/Text

Pos 31 Pos. 32 Pos. 33

English

Hand	○	Auto
Slow	Off	Fast

Catalog No.

List Price

SK 615 550-80

SK 615 552-60

\$ 3.00

Aluminum name plate blank (anodized silvergray aluminum)

Blank 39mm

44.5mm

SK 615 540-1

SK 615 541-1

3.00

① Text height 3 mm. Only the initial character is upper case unless other is stated.

Custom engraved inserts for legend plate holders 22mm

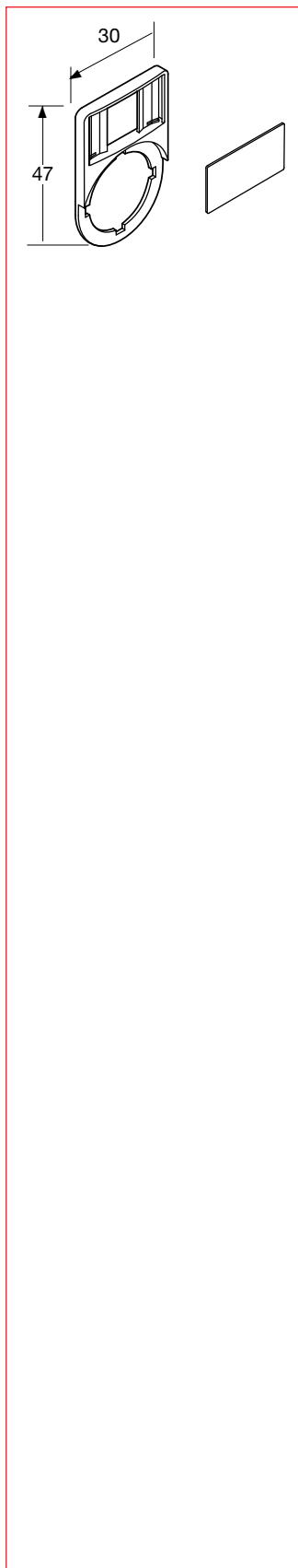

Nameplate Inserts — Brushed aluminum

Type	Maximum letters per line	Catalog number	List price
 1 line	11	MP-NP19-01	\$ 5.90
 2 lines	11	MP-NP19-02	
 2 position selector switch	5	MP-NP19-03	
 3 position selector switch	5	MP-NP19-04	
 2 position selector switch	5	MP-NP19-05	

8

General specifications

1. All characters are 1/8" high, upper & lower case. Please specify if all capital letters are desired.
2. The legend plate inserts and the fixed legend plates are silver-grey anodized aluminum.
3. All special engravings involve engraving the desired lettering into the metal surface and then treating the engraved surfaces with black ink.

EXAMPLE:

MP-NP19-05

1: FWD

2: REV

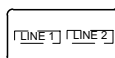

"MP-NP19" is the blank legend plate catalog number. "-05" refers to the layout of text (see dimension illustrations).

Legend Plate order form

Use legend plate order form on next page.

Engraved legend plate form
Custom engraved nameplates
22mm

ENGRAVED LEGEND PLATE FORM
MP-NP19

PAGE: ____ OF: ____

MP-NP19- ____ (BRUSHED ALUMINUM)
ORIG. DATE: _____
ISSUED BY: _____
ALL CAPITALS? YES NO
REMARKS: _____

ORDER NUMBER: _____
ORDER: QTY: _____
SHIPPING METHOD: _____
DUE DATE: ____ - ____ - ____
ENGRAVER: _____
Q.C. INSPECTION: _____

PRINT INFORMATION TO BE ENGRAVED

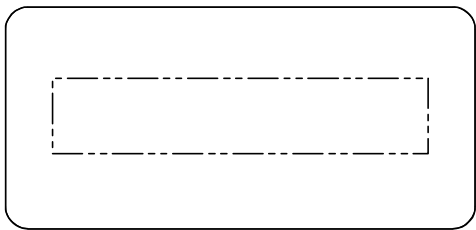

-01

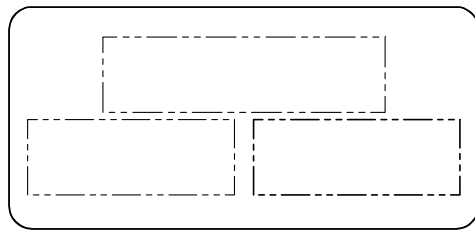

-04

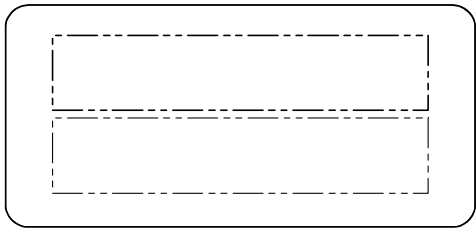

-02

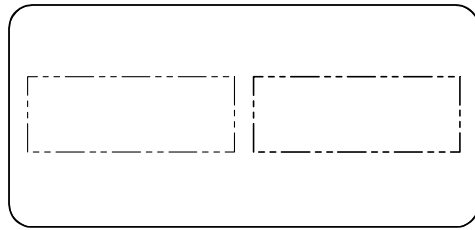

-05

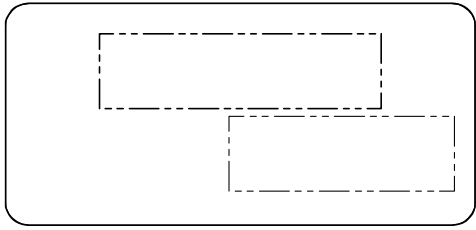



-03

MP-NP19: REV. A
03/04/05

Custom engraved nameplates 22mm

Pilot Devices
Legend plates

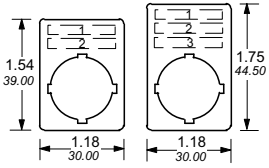
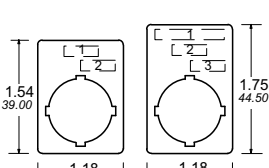
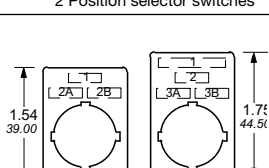
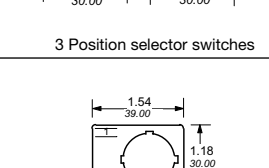
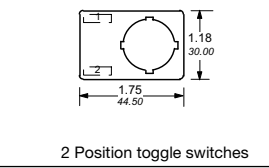
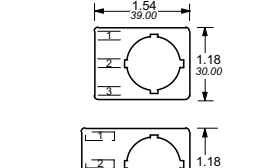
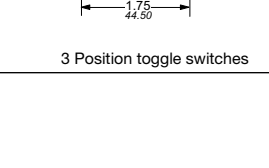
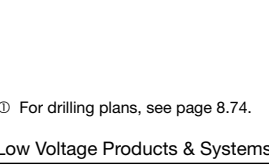
Fixed nameplates – aluminum ①

Type	Maximum letters per line	Catalog number	List price
 Pushbuttons or pilot lights	11	MP-NPE28-01	\$ 6.50
	39mm		
 2 Position selector switches	11	MP-NPE29-01	
	44.5mm		
 2 Position selector switches	5	MP-NPE28-02	
	39mm		
 2 Position selector switches	11 (line 1) 5 (line 2) 5 (line 3)	MP-NPE29-02	
	44.5mm		
 3 Position selector switches	5	MP-NPE28-03	
	39mm		
 3 Position selector switches	11 (line 1) 5 (line 2) 5 (line 3A) 5 (line 3B)	MP-NPE29-03	
	44.5mm		
 2 Position toggle switches	4	MP-NPE28-04	
	39mm		
 2 Position toggle switches	5	MP-NPE29-04	
	44.5mm		
 3 Position toggle switches		MP-NPE28-05	
	39mm		
 3 Position toggle switches		MP-NPE29-05	
	44.5mm		

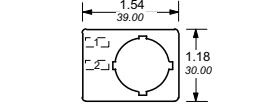
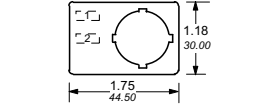
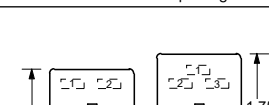
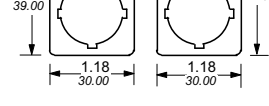

Fixed nameplates – aluminum ①

Type	Maximum letters per line	Catalog number	List price
 Pushbuttons or pilot lights	11	MP-NPE28-06	\$ 6.50
	39mm		
 Pushbuttons or pilot lights	11	MP-NPE29-06	
	44.5mm		
 2 Position selector switches	5	MP-NPE28-07	
	39mm		
 2 Position selector switches	11 (line 1) 5 (line 2) 5 (line 3)	MP-NPE29-07	
	44.5mm		

General specifications

1. All characters are 1/8" high, upper & lower case. Please specify if all capital letters are desired.
2. The legend plate inserts and the fixed legend plates are silver-grey anodized aluminum.
3. All special engravings involve engraving the desired lettering into the metal surface and then treating the engraved surfaces with black ink.

Ordering custom engraved nameplates – USE ORDER FORM FROM FOLLOWING PAGES

1. Select the desired legend plate.
2. Indicate the catalog number.
3. Write the desired words to be engraved on each line.

EXAMPLE:

MP-NPE28P-03

- 1: OFF
- 2: HAND
- 3: AUTO

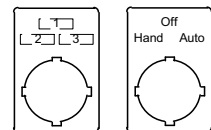

① For drilling plans, see page 8.74.

Engraved legend plate form

Custom engraved nameplates

22mm

ENGRAVED LEGEND PLATE FORM

MP-NPE28

PAGE: ___ OF: ___

MP-NPE28-___ (BRUSHED ALUMNINUM)

ORDER NUMBER: _____

ORIG. DATE: _____

ORDER: QTY: _____

ISSUED BY: _____

SHIPPING METHOD: _____

ALL CAPITALS? YES NO

DUE DATE: ___ - ___ - ___

REMARKS: _____

ENGRAVER: _____

Q.C. INSPECTION: _____

PRINT INFORMATION TO BE ENGRAVED

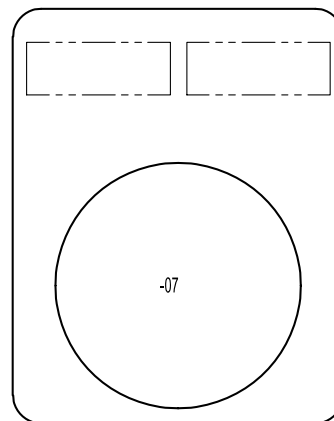
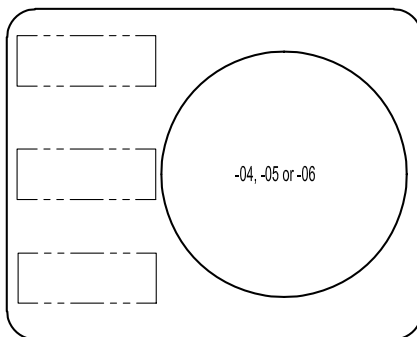
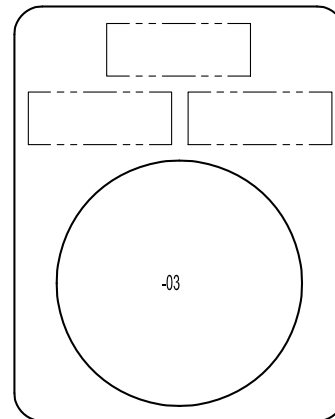
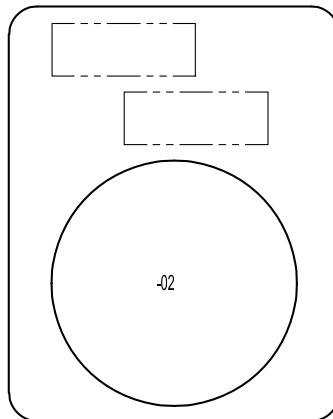
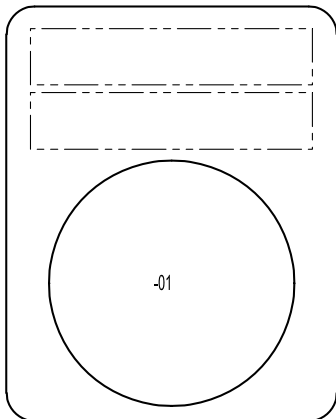

MP-NPE28

5/26/04

Engraved legend plate form
Custom engraved nameplates
22mm

ENGRAVED LEGEND PLATE FORM

MP-NPE29 PAGE: ___ OF: ___

<p>MP-NPE29- ____ (BRUSHED ALUMNINUM) ORIG. DATE: _____ ISSUED BY: _____ ALL CAPITALS? YES NO REMARKS: _____</p>	<p>ORDER NUMBER: _____ ORDER: QTY: _____ SHIPPING METHOD: _____ DUE DATE: ___ - ___ - ___ ENGRAVER: _____ Q.C. INSPECTION: _____</p>
--	---

PRINT INFORMATION TO BE ENGRAVED

MP-NPE29
6/10/04

Special legend plates for plastic enclosures 22mm

Legend plates for plastic enclosures

For 1, 2, 3, 4 or 6-seat

Description	Catalog No.	List price
Of silvergrey aluminum on plastic.		
1-seat	1SFA 611 930 R1000	\$ 12.00
2-seat	1SFA 611 930 R1002	15.00
3-seat	1SFA 611 930 R1003	18.00
4-seat	1SFA 611 930 R1004	21.00
6-seat	1SFA 611 930 R1005	27.00
Of silvergrey aluminum on plastic. (Pos. 1 Yellow)		
2-seat	1SFA 611 930 R1006	20.00
3-seat	1SFA 611 930 R1007	23.00
4-seat	1SFA 611 930 R1008	26.00
6-seat	1SFA 611 930 R1009	32.00

Custom engraved legend plates for plastic enclosures

For 1, 2, 3, 4 or 6-seat

Fill in appropriate templates on the following pages when ordering

Description	Name Plate	Catalog No.	List price
Custom engraved 1-seat	1SFA 611 930 R1000	CUSTOM 1 SEAT	\$ 24.00
Custom engraved 2-seat	1SFA 611 930 R1002	CUSTOM 2 SEAT	30.00
Custom engraved 3-seat	1SFA 611 930 R1003	CUSTOM 3 SEAT	36.00
Custom engraved 4-seat	1SFA 611 930 R1004	CUSTOM 4 SEAT	42.00
Custom engraved 6-seat	1SFA 611 930 R1005	CUSTOM 6 SEAT	54.00
Custom engraved 2-seat, position 1 yellow	1SFA 611 930 R1006	CUSTOM 2 SEAT Y	40.00
Custom engraved 3-seat, position 1 yellow	1SFA 611 930 R1007	CUSTOM 3 SEAT Y	46.00
Custom engraved 4-seat, position 1 yellow	1SFA 611 930 R1008	CUSTOM 4 SEAT Y	52.00
Custom engraved 6-seat, position 1 yellow	1SFA 611 930 R1009	CUSTOM 6 SEAT Y	64.00

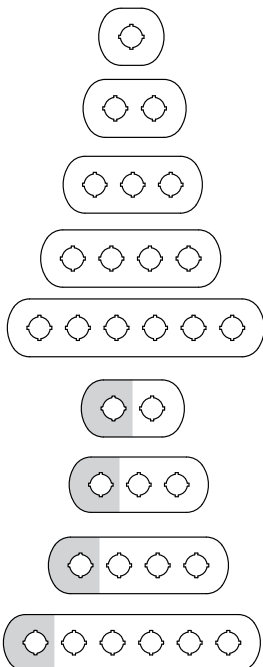

Engraved legend plate form
Custom engraved nameplates
1-Seat, vertical, 22mm

ENGRAVED LEGEND PLATE FORM

PAGE ____ of ____

CUSTOM 1 SEAT
(silver-grey brushed plastic)

ORDER NUMBER : _____ ORDER QTY: _____
SHIPPING METHOD _____ DUE DATE: ____ / ____ / ____
ALL CAPITALS? YES NO
ORDER DATE: _____ ISSUED BY _____
REMARKS: _____

To be completed by ABB personnel.
ENGRAVER _____ Q.C. INSPECTION: _____

PRINT INFORMATION TO BE ENGRAVED:

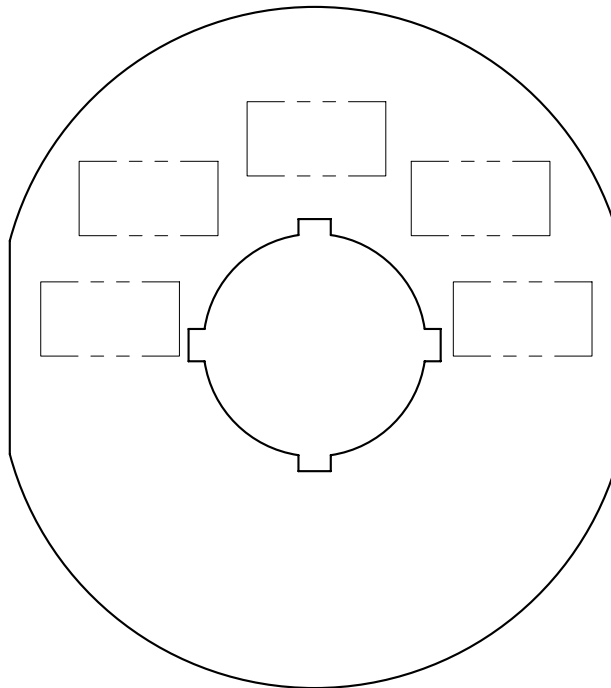

Engraved legend plate form

Custom engraved nameplates

1-Seat, horizontal, 22mm

ENGRAVED LEGEND PLATE FORM

PAGE ____ of ____

CUSTOM 1 SEAT
(silver-grey brushed plastic)

ORDER NUMBER : _____ ORDER QTY: _____
SHIPPING METHOD _____ DUE DATE: ____ / ____ / ____
ALL CAPITALS? YES NO
ORDER DATE: _____ ISSUED BY _____
REMARKS: _____

To be completed by ABB personnel.
ENGRAVER _____ Q.C. INSPECTION : _____

PRINT INFORMATION TO BE ENGRAVED:

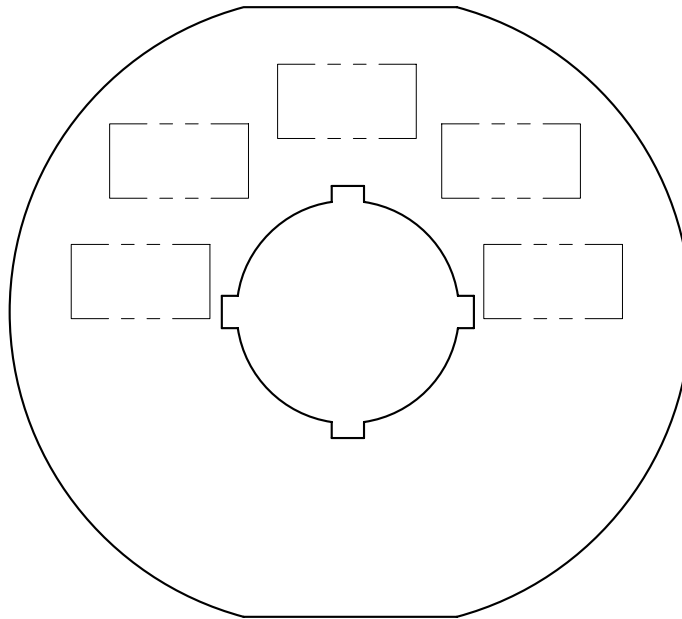

Engraved legend plate form
Custom engraved nameplates
2-Seat, vertical, 22mm

ENGRAVED LEGEND PLATE FORM

PAGE ____ of ____

CIRCLE ONE: **CUSTOM 2 SEAT**
 (silver-grey aluminum)

CUSTOM 2 SEAT Y
 (position 1 yellow)

ORDER NUMBER : _____

ORDER QTY: _____

SHIPPING METHOD _____

DUE DATE: ____ / ____ / ____

ALL CAPITALS? YES NO

ORDER DATE: _____

ISSUED BY _____

REMARKS : _____

To be completed by ABB personnel.

ENGRAVER _____

Q.C. INSPECTION: _____

PRINT INFORMATION TO BE ENGRAVED:

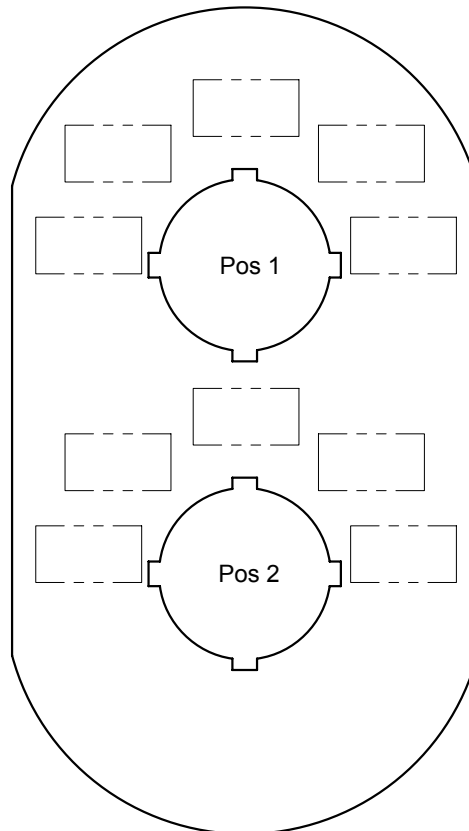

Text cap inserts 22mm

Pilot Devices
Legend plates

Legend	Cap color ①	Suffix code ②	Flush button catalog number	Extended button catalog number	Pilot light catalog number	List price
	White	C82	1SFA 616 901 R9036	—	—	\$ 1.80
Start	White	C67	1SFA 616 901 R2030	1SFA 616 902 R2030	1SFA 616 903 R2030	
START	Green	C5	1SFA 616 906 R1042	—	—	
	Black	C81	1SFA 616 908 R1042	—	—	
On	White	C68	1SFA 616 901 R1020	1SFA 616 902 R1020	1SFA 616 903 R1020	
ON	White	C69	1SFA 616 901 R1039	—	1SFA 616 903 R1039	
	Green	C70	1SFA 616 906 R1039	—	—	
	Black	C1	1SFA 616 908 R1039	—	—	
Off	White	C71	1SFA 616 901 R1019	1SFA 616 902 R1019	1SFA 616 903 R1019	
OFF	White	C72	—	1SFA 616 902 R1040	—	
	Red	C73	—	1SFA 616 905 R1040	—	
	Black	C2	1SFA 616 908 R1040	1SFA 616 909 R1040	—	
Stop	White	C74	1SFA 616 901 R1031	1SFA 616 902 R1031	1SFA 616 903 R1031	
STOP	Red	C4	1SFA 616 904 R1047	1SFA 616 905 R1047	—	
Reset	White	C75	1SFA 616 901 R1025	1SFA 616 902 R1025	1SFA 616 903 R1025	
Blank	White	C15	1SFA 616 901 R9000	1SFA 616 902 R9000	1SFA 616 903 R9000	
	Green	CG	2949 1468-2	2949 1469-2	—	
UP	Green	C11	1SFA 616 906 R1043	—	—	
DOWN	Green	C12	1SFA 616 906 R1044	—	—	
OPEN	White	C16	1SFA 616 901 R1045	—	—	
	Green	C19	1SFA 616 906 R1045	—	—	
CLOSE	White	C17	1SFA 616 901 R1046	—	—	
	Green	C20	1SFA 616 906 R1046	—	—	
REV	Green	C6	1SFA 616 906 R1048	—	—	
FWD	Green	C7	1SFA 616 906 R1049	—	—	
SLOW	Green	C8	1SFA 616 906 R1050	—	—	
FAST	Green	C9	1SFA 616 906 R1051	—	—	
JOG	Green	C10	1SFA 616 906 R1052	—	—	
RESET	Black	C3	1SFA 616 908 R1041	—	—	
LATCH	White	C18	1SFA 616 901 R1053	—	—	

8

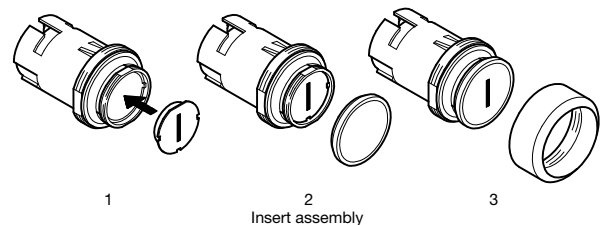
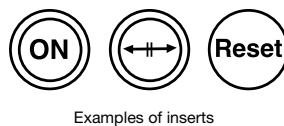
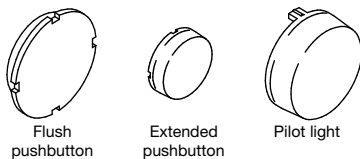

① Illuminated pushbuttons and pilot lights must use white insert.

② For extended pushbuttons, insert "E" at the end of the catalog number. For pilot lights, insert "P" at end of the catalog number.

Text cap inserts 22mm

Flush button

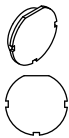

Can be turned 90° or 180°

Extended button



Pilot light

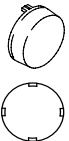

Text caps for illuminated pushbuttons and pilot lights

Text/Symbol ^①	Cap color ^②	Suffix	Flush button Catalog No.	Extended button Catalog No.	Pilot light Catalog No.	List Price
→	White	C14	1SFA 616 901 R9006	1SFA 616 902 R9006	1SFA 616 903 R9006	\$ 1.80
O	White	C21	1SFA 616 901 R9004	1SFA 616 902 R9004	1SFA 616 903 R9004	
	Red	C22	1SFA 616 904 R9004	1SFA 616 905 R9004	–	
	Black	C23	1SFA 616 908 R9004	–	–	
I	White	C24	1SFA 616 901 R9002	1SFA 616 902 R9002	1SFA 616 903 R9002	
	Green	C25	1SFA 616 906 R9002	–	–	
	Black	C26	1SFA 616 908 R9002	–	–	
II	White	C27	1SFA 616 901 R9003	1SFA 616 902 R9003	1SFA 616 903 R9003	
	Green	C28	1SFA 616 906 R9003	–	–	
	Black	C29	1SFA 616 908 R9003	–	–	
III	White	C30	1SFA 616 901 R9028	1SFA 616 902 R9028	–	
	Black	C31	1SFA 616 908 R9028	–	–	
+	White	C32	1SFA 616 901 R9011	1SFA 616 902 R9011	–	
	Green	C33	1SFA 616 906 R9011	–	–	
	Black	C34	1SFA 616 908 R9011	–	–	
–	White	C35	1SFA 616 901 R9012	–	–	
	Red	C36	1SFA 616 904 R9012	–	–	
	Black	C37	1SFA 616 908 R9012	–	–	
↑	White	C38	1SFA 616 901 R9005	1SFA 616 902 R9005	1SFA 616 903 R9005	
	Black	C39	1SFA 616 908 R9005	–	–	
↗	White	C40	1SFA 616 901 R9014	1SFA 616 902 R9014	–	
	Black	C41	1SFA 616 908 R9014	–	–	
↔	White	C42	1SFA 616 901 R9015	1SFA 616 902 R9015	–	
	Black	C43	1SFA 616 908 R9015	–	–	
↔	White	C44	1SFA 616 901 R9016	1SFA 616 902 R9016	–	
	Black	C45	1SFA 616 908 R9016	–	–	
↘	White	C46	1SFA 616 901 R9017	1SFA 616 902 R9017	–	
	Black	C47	1SFA 616 908 R9017	–	–	
⊕	White	C47	1SFA 616 901 R9018	1SFA 616 902 R9018	–	
	Black	C48	1SFA 616 908 R9018	–	–	
●	White	C49	1SFA 616 901 R9019	1SFA 616 902 R9019	–	
	Black	C50	1SFA 616 908 R9019	–	–	
⊙	White	C51	1SFA 616 901 R9020	1SFA 616 902 R9020	–	
	Black	C52	1SFA 616 908 R9020	–	–	
✎	White	C53	1SFA 616 901 R9021	1SFA 616 902 R9021	–	
	Black	C54	1SFA 616 908 R9021	–	–	
⚡	White	C55	1SFA 616 901 R9022	1SFA 616 902 R9022	–	
	Black	C56	1SFA 616 908 R9022	–	–	
⚡	White	C57	1SFA 616 901 R9023	1SFA 616 902 R9023	–	
	Black	C58	1SFA 616 908 R9023	–	–	
⚡	White	C59	1SFA 616 901 R9024	1SFA 616 902 R9024	–	
	Black	C60	1SFA 616 908 R9024	–	–	
⚡	White	C61	1SFA 616 901 R9025	1SFA 616 902 R9025	–	
	Black	C62	1SFA 616 908 R9025	–	–	
⚡	White	C63	1SFA 616 901 R9026	1SFA 616 902 R9026	–	
	Black	C64	1SFA 616 908 R9026	–	–	
⚡	White	C65	1SFA 616 901 R9027	1SFA 616 902 R9027	–	
	Black	C66	1SFA 616 908 R9027	–	–	

① Use only white caps for illuminated pushbutton and pilot lights.

② Add "E" for extended button or "P" for pilot light.



Legend plates 30mm



Custom legend plates

- Legend plate with customer selected text

Text caps

- For illuminated pushbuttons (flush or extended) and pilot lights
- With or without text or symbol or with customer selected text

30mm Legend plates

Legend plates for pushbuttons 30mm

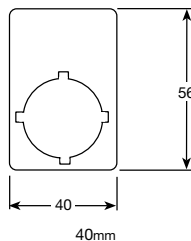
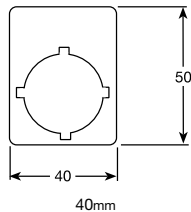

Blank fixed legend plates

Of silvergrey aluminum

Size	Catalog Number	List Price
50mm H	SK 615 640-1	\$ 1.80
56mm H	SK 615 641-1	

Engraved fixed legend plates, with text ①

Of silvergrey aluminum, 50mm H

Text	Catalog Number	List Price
English		
Close	SK 615 652-13	\$ 1.80
Down	SK 615 652-14	
Emergency stop	SK 615 652-15	
Fast	SK 615 652-16	
Forward	SK 615 652-17	
In	SK 615 650-29	
Inching	SK 615 652-18	
Jog	SK 615 652-JO	
Left	SK 615 652-39	
Lower	SK 615 652-20	
Off	SK 615 652-21	
On	SK 615 652-22	
Open	SK 615 652-23	
Out	SK 615 652-24	
Raise	SK 615 652-25	
Reset	SK 615 652-27	
Reverse	SK 615 652-28	
Right	SK 615 652-40	
Run	SK 615 652-29	
Slow	SK 615 652-30	
Start	SK 615 652-44	
Stop	SK 615 652-31	
Up	SK 615 652-32	

① Text height 3 mm.

Legend plates for selector switches 30mm

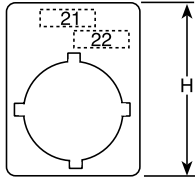

2 Positions

Engraved fixed legend plates, with text ①

Of silvergrey aluminum, 50mm H

Symbol/Text

Pos 21 Pos. 22

English

Fwd Rev
Hand Auto
Jog Run
Off On
Stop Start

Catalog Number

List Price

SK 615 652-FR
SK 615 652-71
SK 615 652-52
SK 615 652-53
SK 615 652-55

\$ 1.80

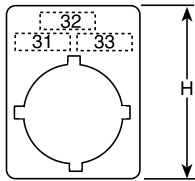

3 Positions

Engraved fixed legend plates, with text ①

Of silvergrey aluminum, 50mm H

Symbol/Text

Pos 31 Pos. 32 Pos. 33

English

Hand O Auto
Slow Off Fast

Catalog Number

List Price



SK 615 652-80
SK 615 652-60

\$ 1.80

① Text height 3 mm. Only the initial character is upper case unless other is stated.

Custom engraved legend plates 30mm

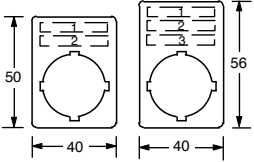
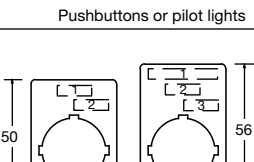
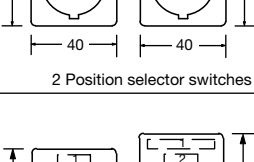
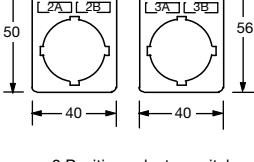
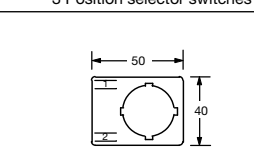
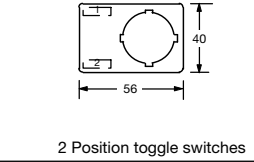
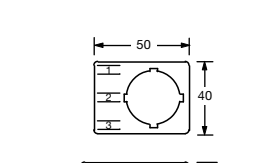
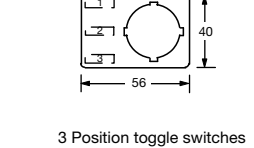
Fixed nameplates — aluminum

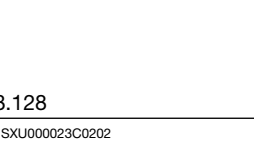
Type	Maximum letters per line	Catalog number	List price
 Pushbuttons or pilot lights	11	G1MP-NPE28-01	\$ 6.50
	50mm		
 Pushbuttons or pilot lights	11	G1MP-NPE29-01	\$ 6.50
	56mm		
 2 Position selector switches	5	G1MP-NPE28-02	\$ 6.50
	50mm		
 2 Position selector switches	11 (line 1) 5 (line 2) 5 (line 3)	G1MP-NPE29-02	\$ 6.50
	56mm		
 3 Position selector switches	5	G1MP-NPE28-03	\$ 6.50
	50mm		
 3 Position selector switches	11 (line 1) 5 (line 2) 5 (line 3A) 5 (line 3B)	G1MP-NPE29-03	\$ 6.50
	56mm		
 2 Position toggle switches	4	G1MP-NPE28-04	\$ 6.50
	50mm		
 2 Position toggle switches	5	G1MP-NPE29-04	\$ 6.50
	56mm		
 3 Position toggle switches		G1MP-NPE28-05	\$ 6.50
	50mm		
 3 Position toggle switches		G1MP-NPE29-05	\$ 6.50
	56mm		

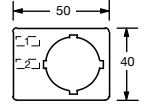
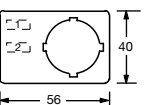
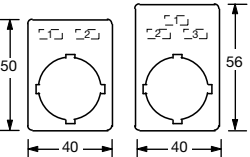
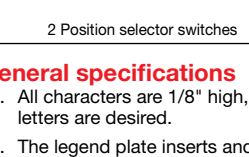

Fixed nameplates — aluminum

Type	Maximum letters per line	Catalog number	List price
 Pushbuttons or pilot lights	11	G1MP-NPE28-06	\$ 6.50
	50mm		
 Pushbuttons or pilot lights	11	G1MP-NPE29-06	\$ 6.50
	56mm		
 2 Position selector switches	5	G1MP-NPE28-07	\$ 6.50
	50mm		
 2 Position selector switches	11 (line 1) 5 (line 2) 5 (line 3)	G1MP-NPE29-07	\$ 6.50
	56mm		

General specifications

- All characters are 1/8" high, upper & lower case. Please specify if all capital letters are desired.
- The legend plate inserts and the fixed legend plates are silver-grey anodized aluminum.
- All special engravings involve engraving the desired lettering into the metal surface and then treating the engraved surfaces with black ink.

Ordering custom engraved nameplates

- Select the desired legend plate.
- Use following pages to order.
- Indicate the catalog number.
- Write the desired words to be engraved on each line.

EXAMPLE:

G1MP-NPE28P-03

- OFF
- HAND
- AUTO

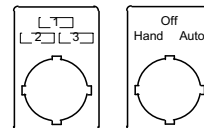

Engraved legend plate form
Custom engraved legend plates
30mm

ENGRAVED LEGEND PLATE FORM

G1MP-NPE28 PAGE: ___ OF: ___

G1MP-NPE28-____ (BRUSHED ALUMNINUM) ORIG. DATE: _____ ISSUED BY: _____ ALL CAPITALS? YES NO REMARKS: _____	ORDER NUMBER: _____ ORDER: QTY: _____ SHIPPING METHOD: _____ DUE DATE: ___ - ___ - ___ ENGRAVER: _____ Q.C. INSPECTION: _____
--	--

PRINT INFORMATION TO BE ENGRAVED

-01

-02

-03

-04, -05 or -06

-07

G1MP-NPE28
6/10/04

Engraved legend plate form

Custom engraved legend plates
30mm

ENGRAVED LEGEND PLATE FORM

G1MP-NPE29

PAGE: ___ OF: ___

G1MP-NPE29-___ (BRUSHED ALUMINUM)

ORDER NUMBER: _____

ORIG. DATE: _____

ORDER: QTY: _____

ISSUED BY: _____

SHIPPING METHOD: _____

ALL CAPITALS? YES NO

DUE DATE: ___ - ___ - ___

REMARKS: _____

ENGRAVER: _____

Q.C. INSPECTION: _____

PRINT INFORMATION TO BE ENGRAVED

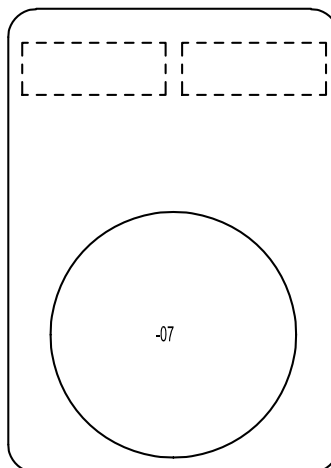
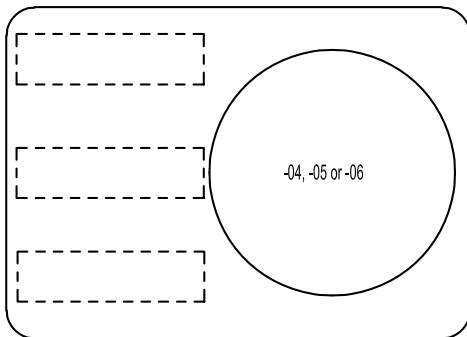
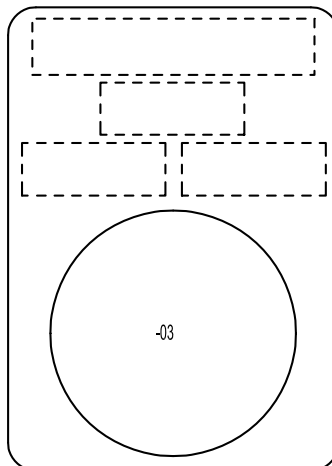
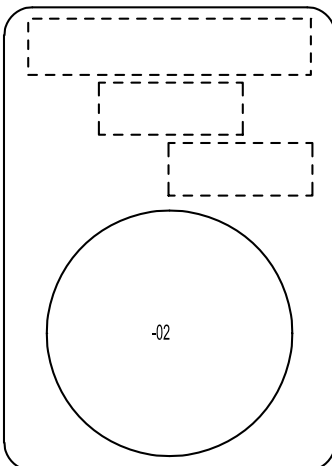
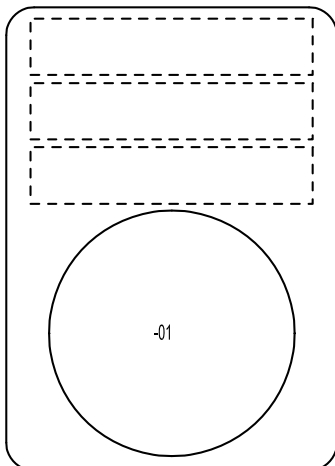

G1MP-NPE29

6/10/04

Text cap inserts 30mm

Pilot Devices
Legend plates

Legend	Cap color ①	Suffix code ②	Flush button catalog number	Extended button catalog number	Pilot light catalog number	List price
	White	C82	1SFA 616 901 R9036	—	—	\$ 1.80
Start	White	C67	1SFA 616 901 R2030	1SFA 616 902 R2030	1SFA 616 903 R2030	
START	Green	C5	1SFA 616 906 R1042	—	—	
	Black	C81	1SFA 616 908 R1042	—	—	
On	White	C68	1SFA 616 901 R1020	1SFA 616 902 R1020	1SFA 616 903 R1020	
ON	White	C69	1SFA 616 901 R1039	—	1SFA 616 903 R1039	
	Green	C70	1SFA 616 906 R1039	—	—	
	Black	C1	1SFA 616 908 R1039	—	—	
Off	White	C71	1SFA 616 901 R1019	1SFA 616 902 R1019	1SFA 616 903 R1019	
OFF	White	C72	—	1SFA 616 902 R1040	—	
	Red	C73	—	1SFA 616 905 R1040	—	
	Black	C2	1SFA 616 908 R1040	1SFA 616 909 R1040	—	
Stop	White	C74	1SFA 616 901 R1031	1SFA 616 902 R1031	1SFA 616 903 R1031	
STOP	Red	C4	1SFA 616 904 R1047	1SFA 616 905 R1047	—	
Reset	White	C75	1SFA 616 901 R1025	1SFA 616 902 R1025	1SFA 616 903 R1025	
Blank	White	C15	1SFA 616 901 R9000	1SFA 616 902 R9000	1SFA 616 903 R9000	
	Green	CG	2949 1468-2	2949 1469-2	—	
UP	Green	C11	1SFA 616 906 R1043	—	—	
DOWN	Green	C12	1SFA 616 906 R1044	—	—	
OPEN	White	C16	1SFA 616 901 R1045	—	—	
	Green	C19	1SFA 616 906 R1045	—	—	
CLOSE	White	C17	1SFA 616 901 R1046	—	—	
	Green	C20	1SFA 616 906 R1046	—	—	
REV	Green	C6	1SFA 616 906 R1048	—	—	
FWD	Green	C7	1SFA 616 906 R1049	—	—	
SLOW	Green	C8	1SFA 616 906 R1050	—	—	
FAST	Green	C9	1SFA 616 906 R1051	—	—	
JOG	Green	C10	1SFA 616 906 R1052	—	—	
RESET	Black	C3	1SFA 616 908 R1041	—	—	
LATCH	White	C18	1SFA 616 901 R1053	—	—	

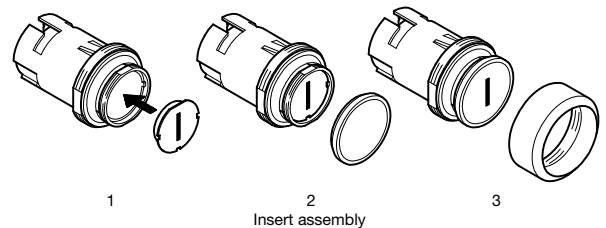
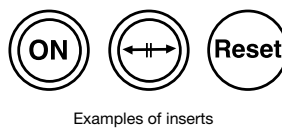
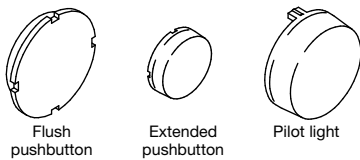

① Illuminated pushbuttons and pilot lights must use white insert.
② Add suffix code to end of the catalog number.

Text cap inserts 30mm

Text caps for illuminated pushbuttons and pilot lights

Flush button



Can be turned 90° or 180°

Extended button



Pilot light



Text/Symbol ^①	Cap color	Suffix ^②	Flush button Catalog No.	Extended button Catalog No.	Pilot light Catalog No.	List Price
→	White	C14	1SFA 616 901 R9006	1SFA 616 902 R9006	1SFA 616 903 R9006	\$ 1.80
O	White	C21	1SFA 616 901 R9004	1SFA 616 902 R9004	1SFA 616 903 R9004	
	Red	C22	1SFA 616 904 R9004	1SFA 616 905 R9004	-	
	Black	C23	1SFA 616 908 R9004	-	-	
I	White	C24	1SFA 616 901 R9002	1SFA 616 902 R9002	1SFA 616 903 R9002	
	Green	C25	1SFA 616 906 R9002	-	-	
	Black	C26	1SFA 616 908 R9002	-	-	
II	White	C27	1SFA 616 901 R9003	1SFA 616 902 R9003	1SFA 616 903 R9003	
	Green	C28	1SFA 616 906 R9003	-	-	
	Black	C29	1SFA 616 908 R9003	-	-	
III	White	C30	1SFA 616 901 R9028	1SFA 616 902 R9028	-	
	Black	C31	1SFA 616 908 R9028	-	-	
+	White	C32	1SFA 616 901 R9011	1SFA 616 902 R9011	-	
	Green	C33	1SFA 616 906 R9011	-	-	
	Black	C34	1SFA 616 908 R9011	-	-	
-	White	C35	1SFA 616 901 R9012	-	-	
	Red	C36	1SFA 616 904 R9012	-	-	
	Black	C37	1SFA 616 908 R9012	-	-	
↑	White	C38	1SFA 616 901 R9005	1SFA 616 902 R9005	1SFA 616 903 R9005	
	Black	C39	1SFA 616 908 R9005	-	-	
↗	White	C40	1SFA 616 901 R9014	1SFA 616 902 R9014	-	
	Black	C41	1SFA 616 908 R9014	-	-	
↔	White	C42	1SFA 616 901 R9015	1SFA 616 902 R9015	-	
	Black	C43	1SFA 616 908 R9015	-	-	
↔↔	White	C44	1SFA 616 901 R9016	1SFA 616 902 R9016	-	
	Black	C45	1SFA 616 908 R9016	-	-	
⤵	White	C46	1SFA 616 901 R9017	1SFA 616 902 R9017	-	
	Black	C47	1SFA 616 908 R9017	-	-	
⊕	White	C47	1SFA 616 901 R9018	1SFA 616 902 R9018	-	
	Black	C48	1SFA 616 908 R9018	-	-	
●	White	C49	1SFA 616 901 R9019	1SFA 616 902 R9019	-	
	Black	C50	1SFA 616 908 R9019	-	-	
⊙	White	C51	1SFA 616 901 R9020	1SFA 616 902 R9020	-	
	Black	C52	1SFA 616 908 R9020	-	-	
✋	White	C53	1SFA 616 901 R9021	1SFA 616 902 R9021	-	
	Black	C54	1SFA 616 908 R9021	-	-	
⚡	White	C55	1SFA 616 901 R9022	1SFA 616 902 R9022	-	
	Black	C56	1SFA 616 908 R9022	-	-	
⚡	White	C57	1SFA 616 901 R9023	1SFA 616 902 R9023	-	
	Black	C58	1SFA 616 908 R9023	-	-	
⚡	White	C59	1SFA 616 901 R9024	1SFA 616 902 R9024	-	
	Black	C60	1SFA 616 908 R9024	-	-	
⚡	White	C61	1SFA 616 901 R9025	1SFA 616 902 R9025	-	
	Black	C62	1SFA 616 908 R9025	-	-	
⚡	White	C63	1SFA 616 901 R9026	1SFA 616 902 R9026	-	
	Black	C64	1SFA 616 908 R9026	-	-	
⚡	White	C65	1SFA 616 901 R9027	1SFA 616 902 R9027	-	
	Black	C66	1SFA 616 908 R9027	-	-	

① Use only white caps for illuminated pushbutton and pilot lights.

② Add suffix code to end of the catalog number.